

Easy Series

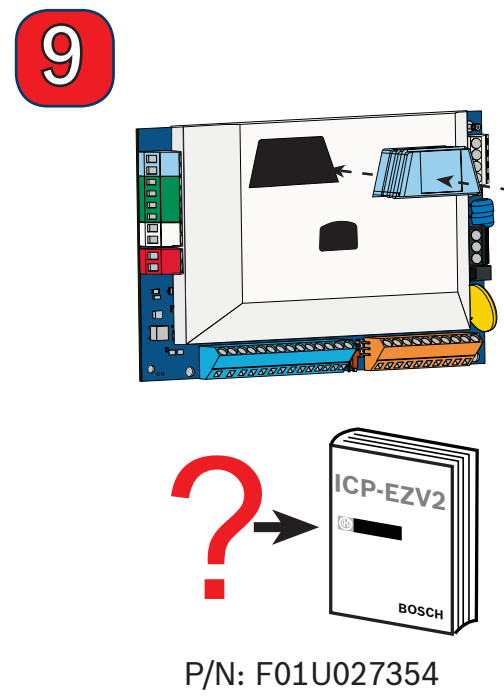

11

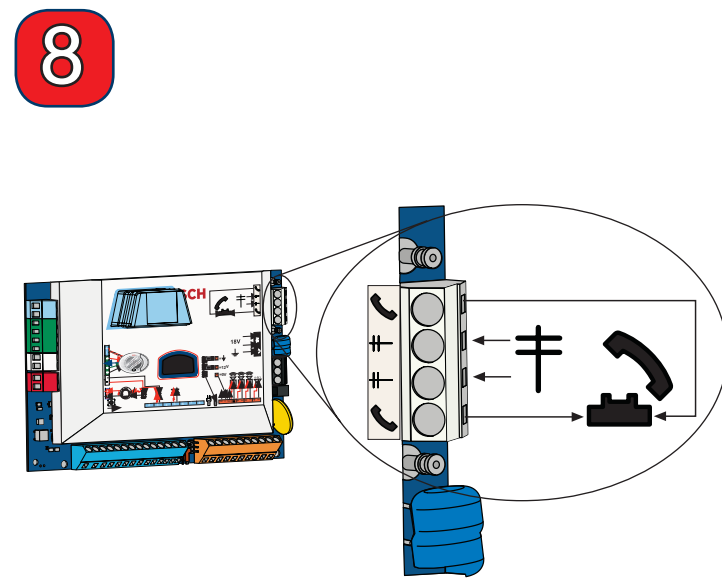
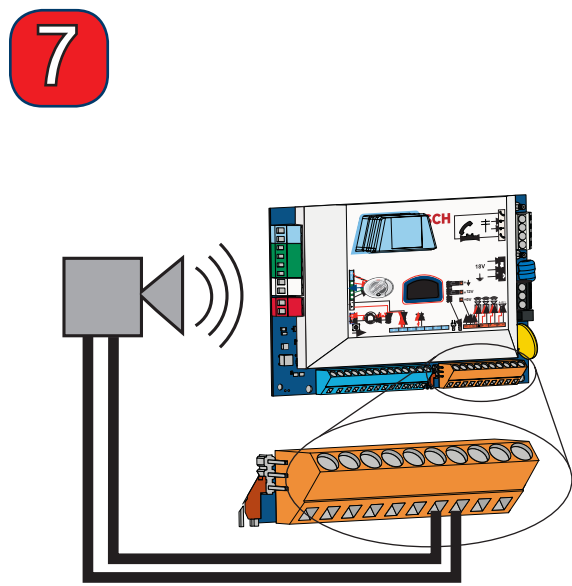
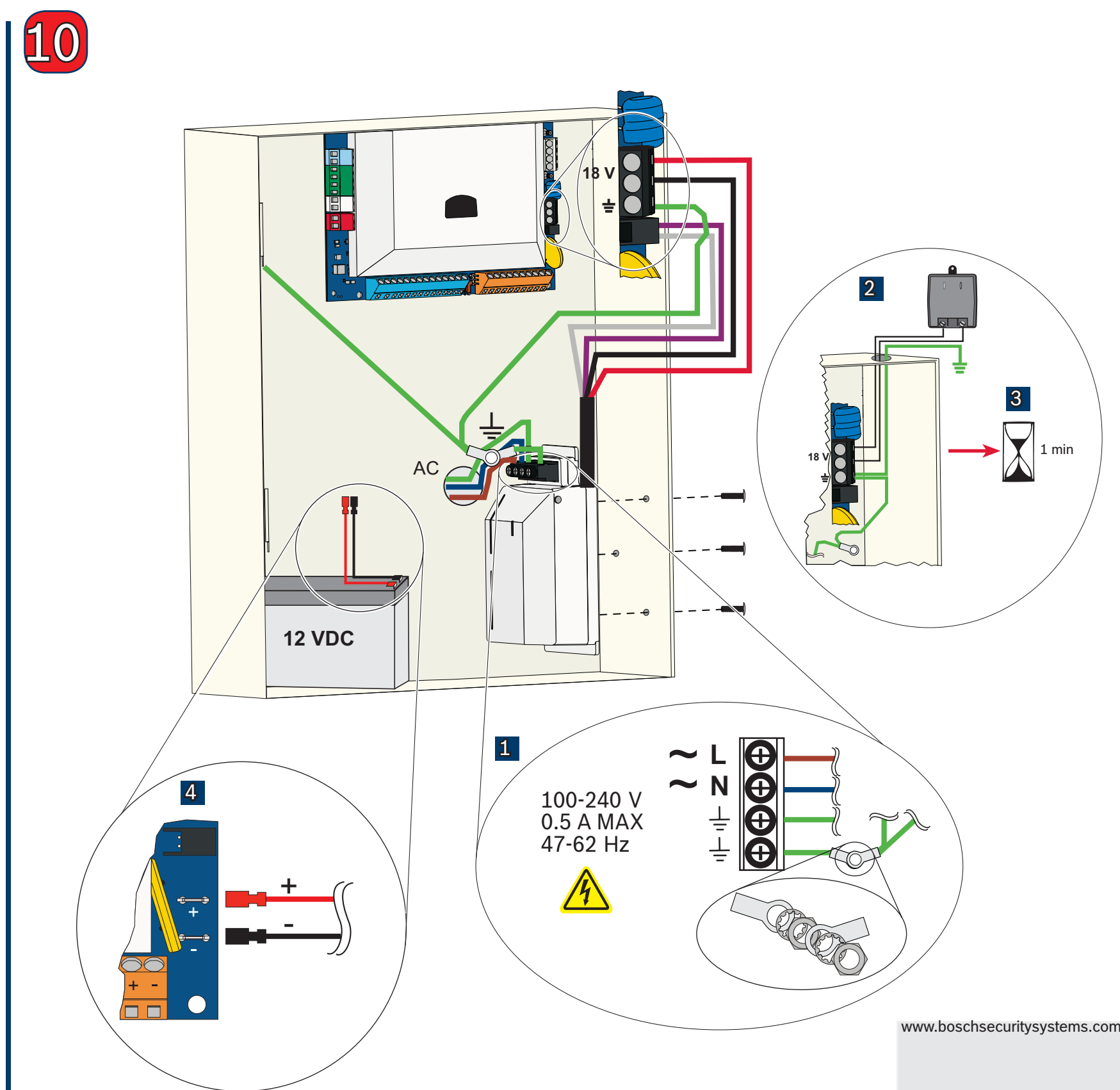
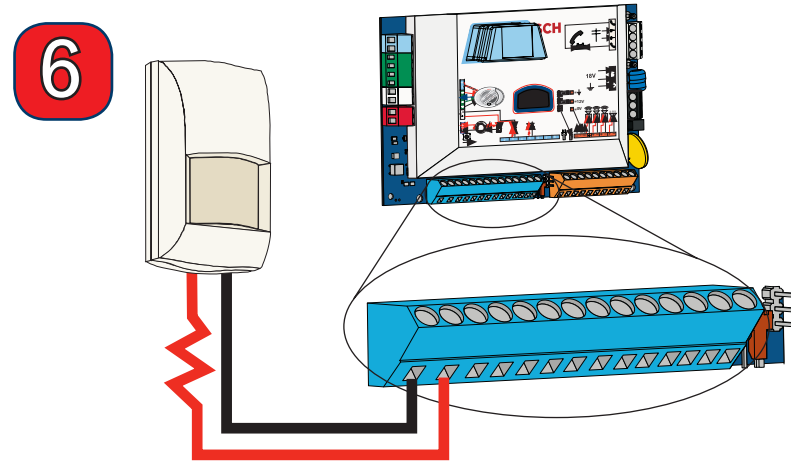
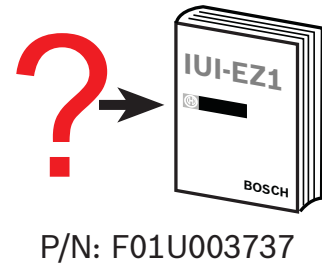
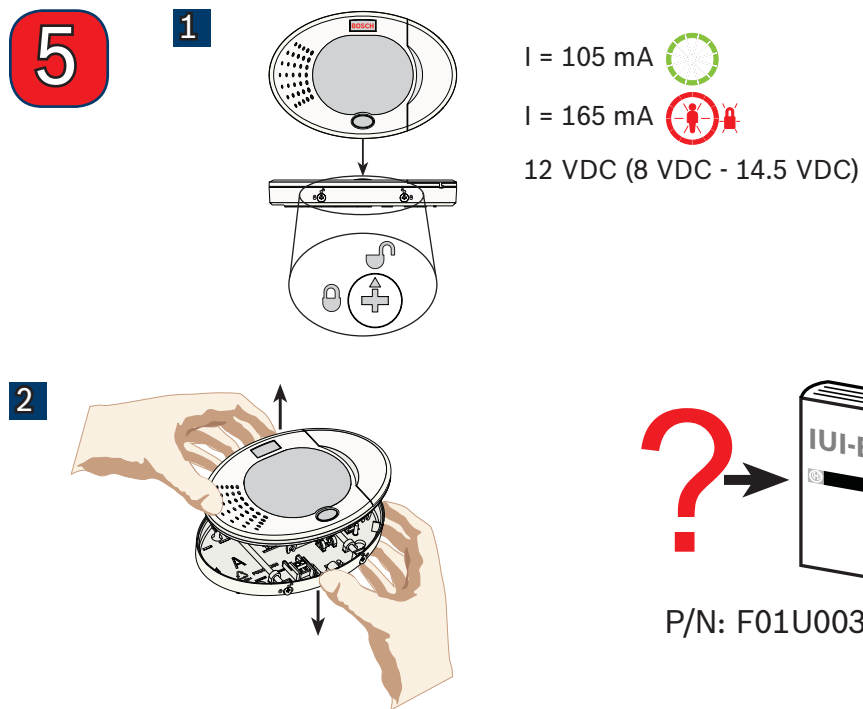
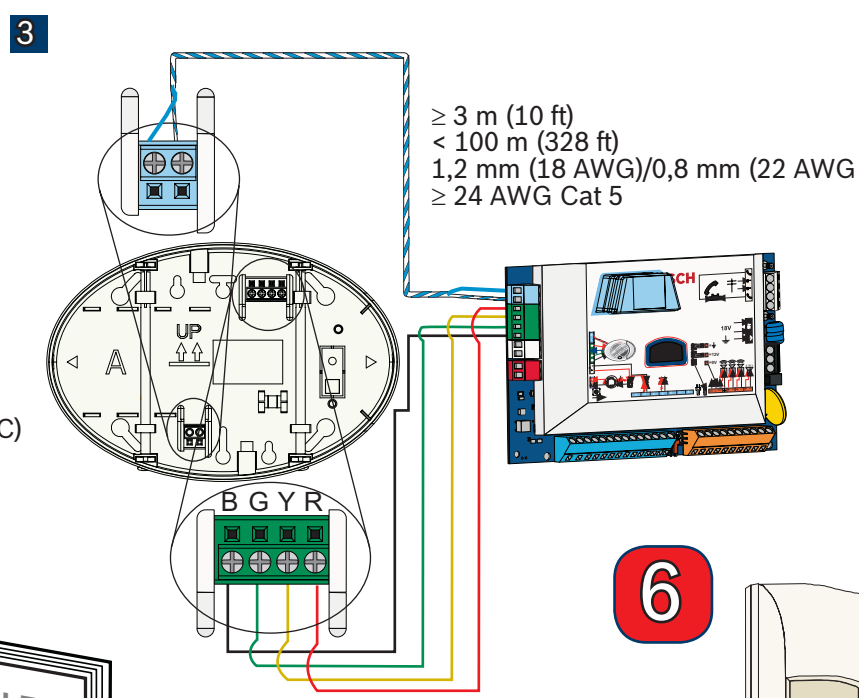
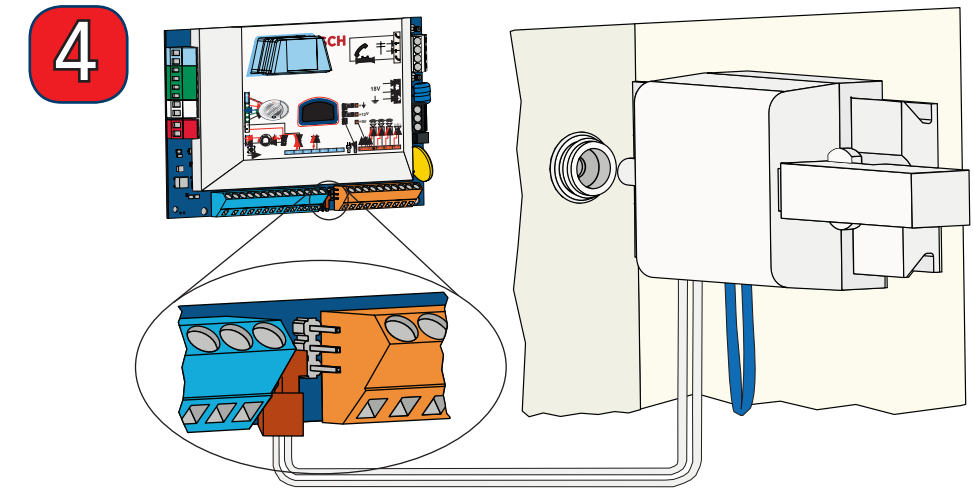
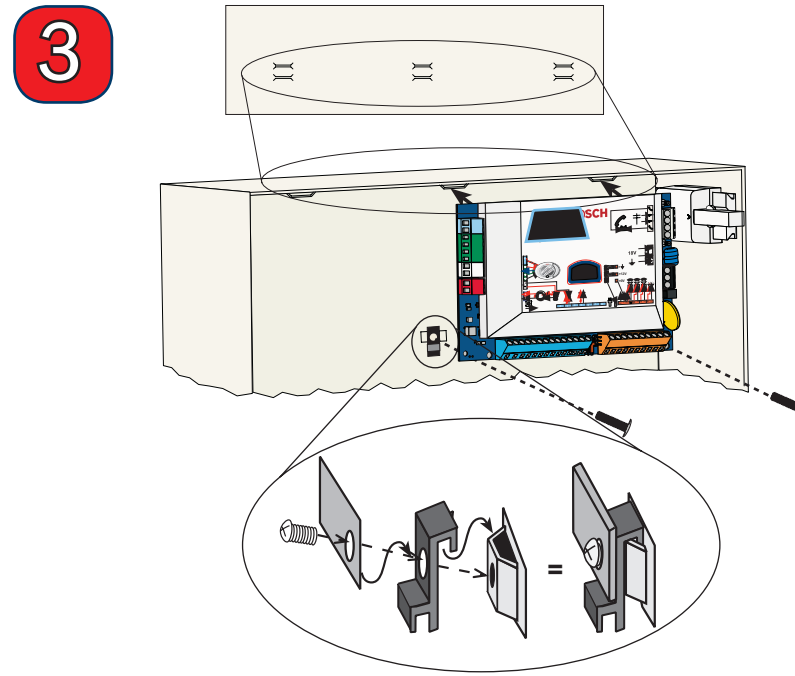
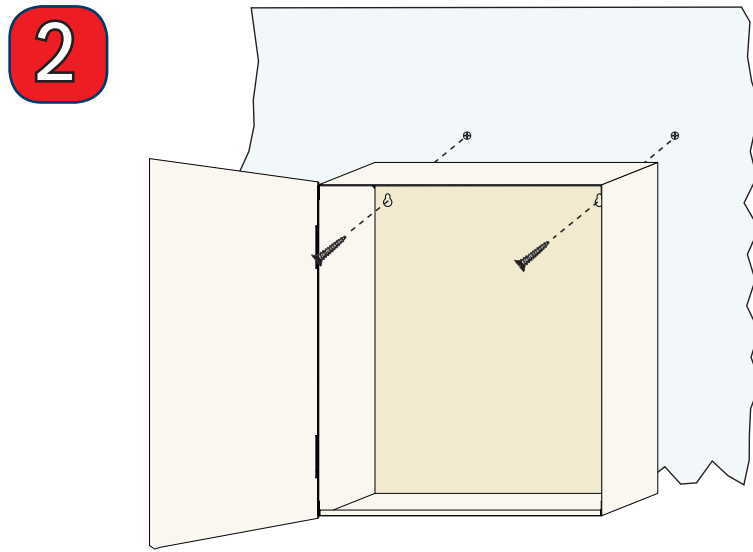
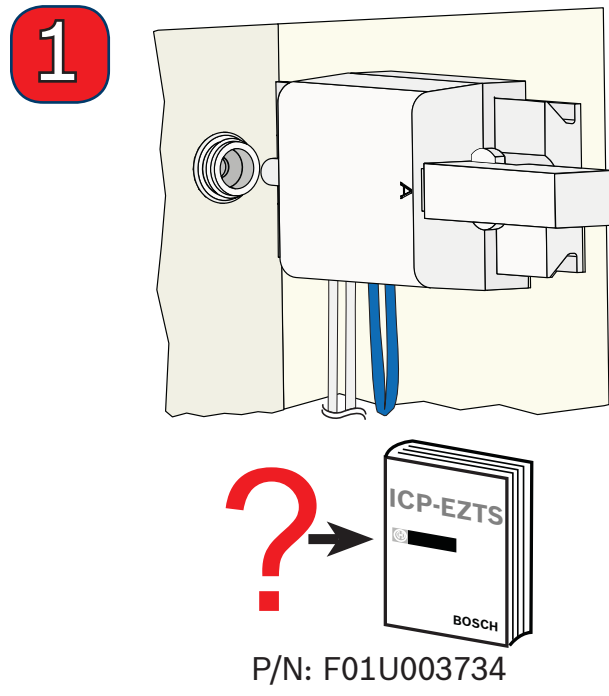
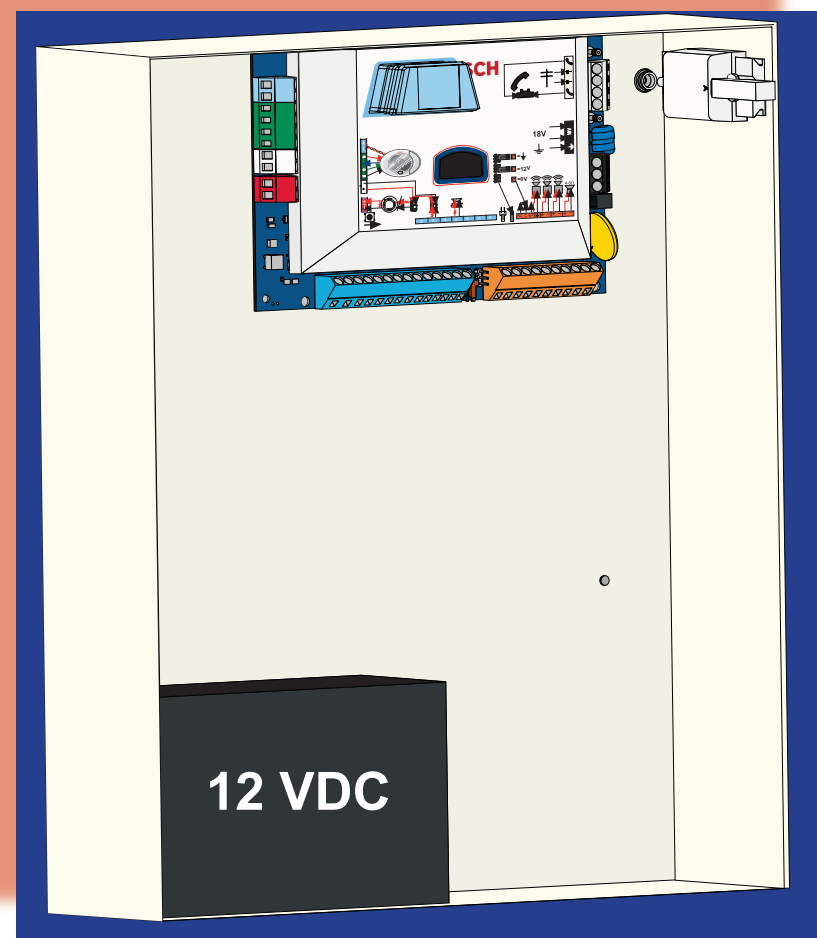
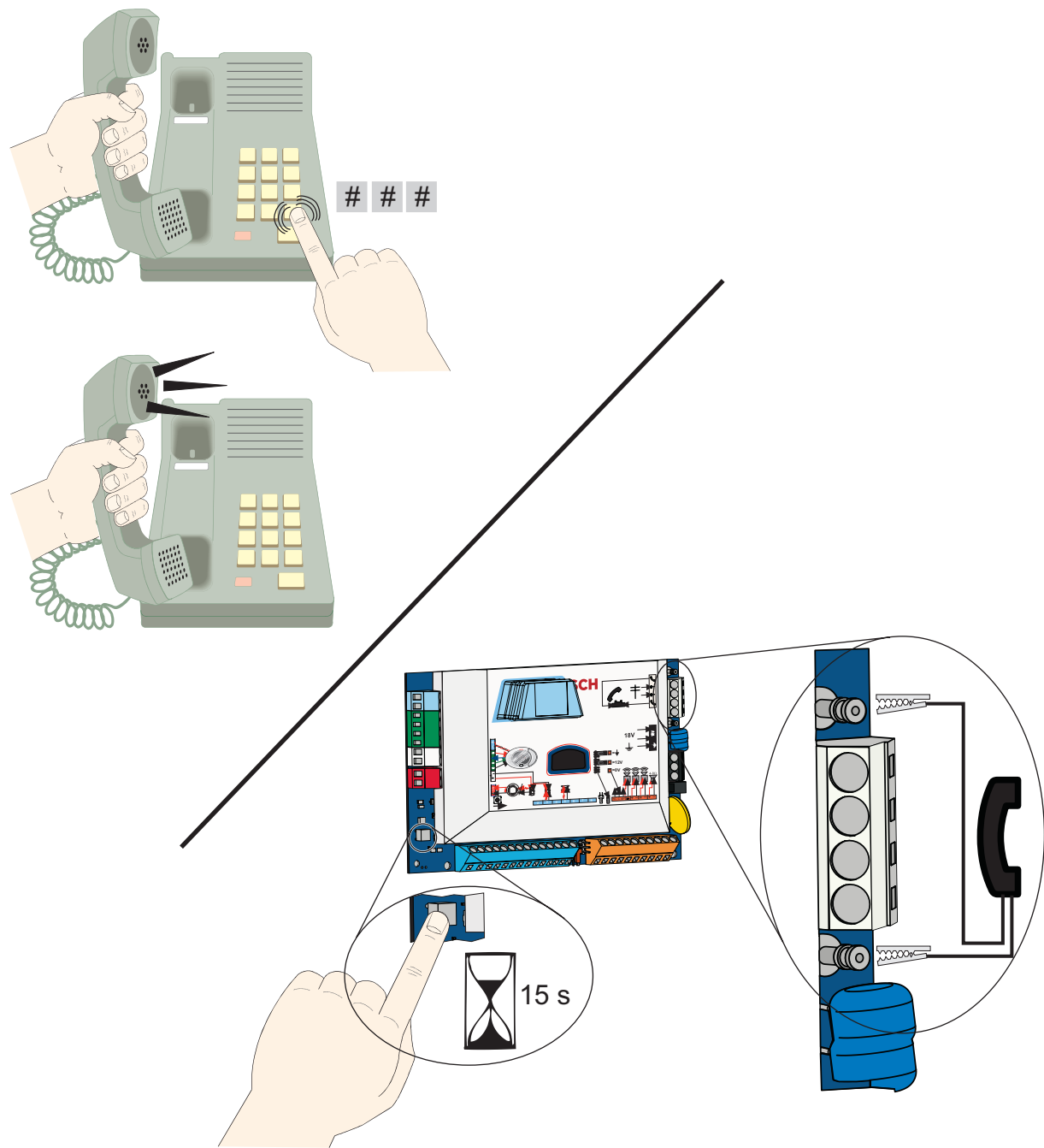

12

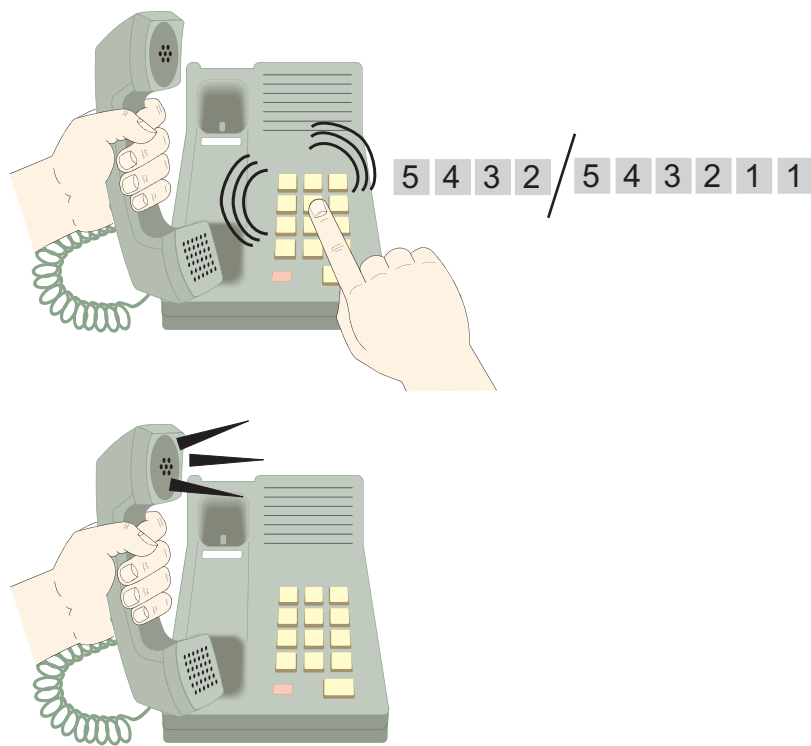

13



65	AG	Afghanistan	65	GH	Ghana	37	NG	Nigeria
65	AL	Albania	19	GR	Greece	38	NO	Norway
63	DZ	Algeria	65	GL	Greenland	62	OM	Oman
65	AD	Andorra	65	GD	Grenada	62	PK	Pakistan
65	AO	Angola	65	GT	Guatemala	65	PW	Palau
65	AG	Antigua and Barbuda	65	GN	Guinea	65	PA	Panama
01	AR	Argentina	65	GW	Guinea-Bissau	65	PG	Papua New Guinea
62	AM	Armenia	65	GY	Guyana	65	PY	Paraguay
02	AU	Australia	65	HT	Haiti	39	PE	Peru
03	AT	Austria	65	VA	Holy See	40	PH	Philippines
65	AZ	Azerbaijan	65	HN	Honduras	41	PL	Poland
65	BS	Bahamas	20	HK	Hong Kong	42	PT	Portugal
63	BH	Bahrain	21	HU	Hungary	62	QA	Qatar
65	BD	Bangladesh	63	IS	Iceland	43	RO	Romania
65	BB	Barbados	22	IN	India	44	RU	Russian Federation
62	BY	Belarus	23	ID	Indonesia	65	RW	Rwanda
04	BE	Belgium	65	IR	Iran	65	KN	St. Kitts and Nevis
65	BZ	Belize	65	IQ	Iraq	65	LC	St. Lucia
65	BJ	Benin	24	IE	Ireland	65	VC	St. Vincent and Grenadines
65	BT	Bhutan	63	IL	Israel	65	AS	American Samoa
65	BO	Bolivia	25	IT	Italy	65	ST	Sao Tome and Principe
65	BA	Bosnia and Herzegovina	65	CI	Ivory Coast	45	SA	Saudi Arabia
65	BW	Botswana	65	JM	Jamaica	65	SN	Senegal
05	BR	Brazil	26	JP	Japan	46	CS	Serbia and Montenegro
65	BN	Brunei	62	JO	Jordan	65	SC	Seychelles
06	BG	Bulgaria	62	KZ	Kazakhstan	65	SL	Sierra Leone
65	BF	Burkina Faso	65	KE	Kenya	47	SG	Singapore
65	MM	Burma (Myanmar)	65	KI	Kiribati	48	SK	Slovakia
65	BI	Burundi	65	KP	Korea, North	49	SI	Slovenia
65	KH	Cambodia	27	KR	Korea, South	65	SB	Solomon Islands
65	CM	Cameroon	65	KW	Kuwait	65	SO	Somalia
07	CA	Canada	62	KG	Kyrgyzstan	50	ZA	South Africa
65	CV	Cape Verde	65	LA	Laos	51	ES	Spain
65	CF	Central African Republic	28	LV	Latvia	65	LK	Sri Lanka
65	TD	Chad	63	LB	Lebanon	65	SD	Sudan
65	CL	Chile	65	LS	Lesotho	65	SR	Suriname
08	CN	China	65	LR	Liberia	65	SZ	Swazilands
09	CO	Columbia	65	LY	Libya	52	SE	Sweden
65	KM	Comoros	63	LI	Liechtenstein	53	CH	Switzerland
65	CG	Congo (Brazzaville)	29	LT	Lithuania	62	SY	Syria
65	CG	Congo (Kinshasa)	30	LU	Luxembourg	54	TW	Taiwan
65	CR	Costa Rica	31	MK	Macedonia	65	TJ	Tadjikistan
10	HR	Croatia	65	MG	Madagascar	65	TZ	Tanzania
65	CU	Cuba	65	MW	Malawi	55	TH	Thailand
11	CY	Cyprus	32	MY	Malaysia	65	TG	Togo
12	CZ	Czech Republic	65	MV	Maldives	65	TO	Tonga
13	DK	Denmark	65	ML	Mali	65	TT	Trinidad and Tobago
65	DJ	Djibouti	33	MT	Malta	65	TN	Tunisia
65	DM	Dominica	65	MH	Marshall Islands	56	TR	Turkey
65	DO	Dominican Republic	65	MR	Mauritania	65	TM	Turkmenistan
65	TP	East Timor	65	MU	Mauritius	65	TV	Tuvalu
65	EC	Ecuador	34	MX	Mexico	65	UG	Uganda
14	EG	Egypt	65	FM	Micronesia	62	UA	Ukraine
65	SV	El Salvador	62	MD	Moldova	65	AE	United Arabs Emirate
65	GQ	Equatorial Guinea	65	MC	Monaco	57	UK	United Kingdom
65	ER	Eritrea	65	MN	Mongolia	58	US	United States
15	EE	Estonia	63	MA	Morocco	65	UY	Uruguay
65	ET	Ethiopia	65	MZ	Mozambique	65	UZ	Uzbekistan
65	FJ	Fiji	65	NA	Namibia	65	VU	Vanuatu
16	FI	Finland	65	NR	Nauru	59	VE	Venezuela
17	FR	France	65	NP	Nepal	60	VN	Vietnam
63	PF	French Polynesia	35	NL	Netherlands	65	YE	Yemen
65	GA	Gabon	36	NZ	New Zealand	63	ZM	Zambia
65	GM	Gambia	65	NI	Nicaragua	65	ZW	Zimbabwe
62	GE	Georgia	65	NE	Niger			
18	DE	Germany						

14

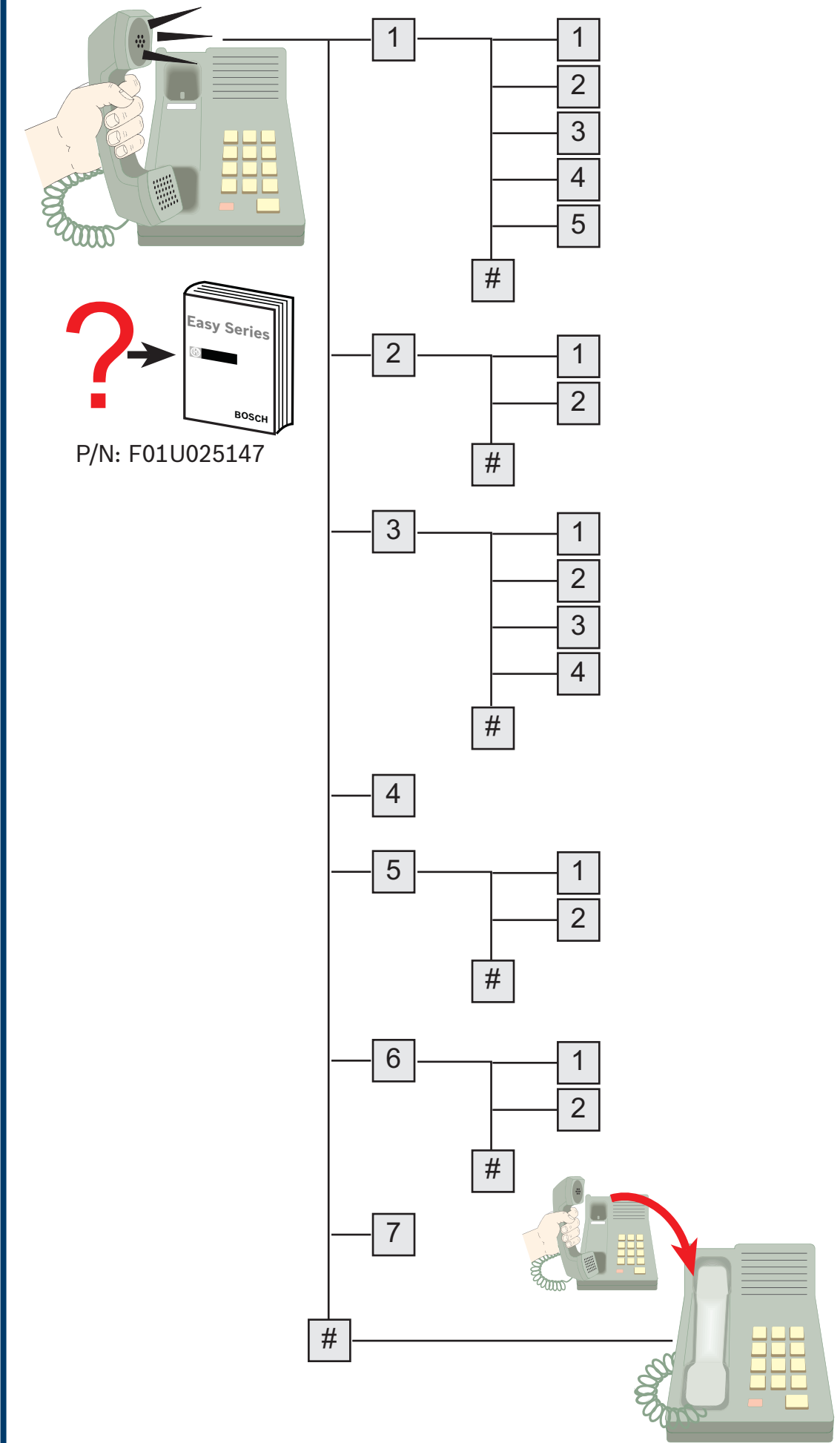

15

